

Wall and roof conductor holders

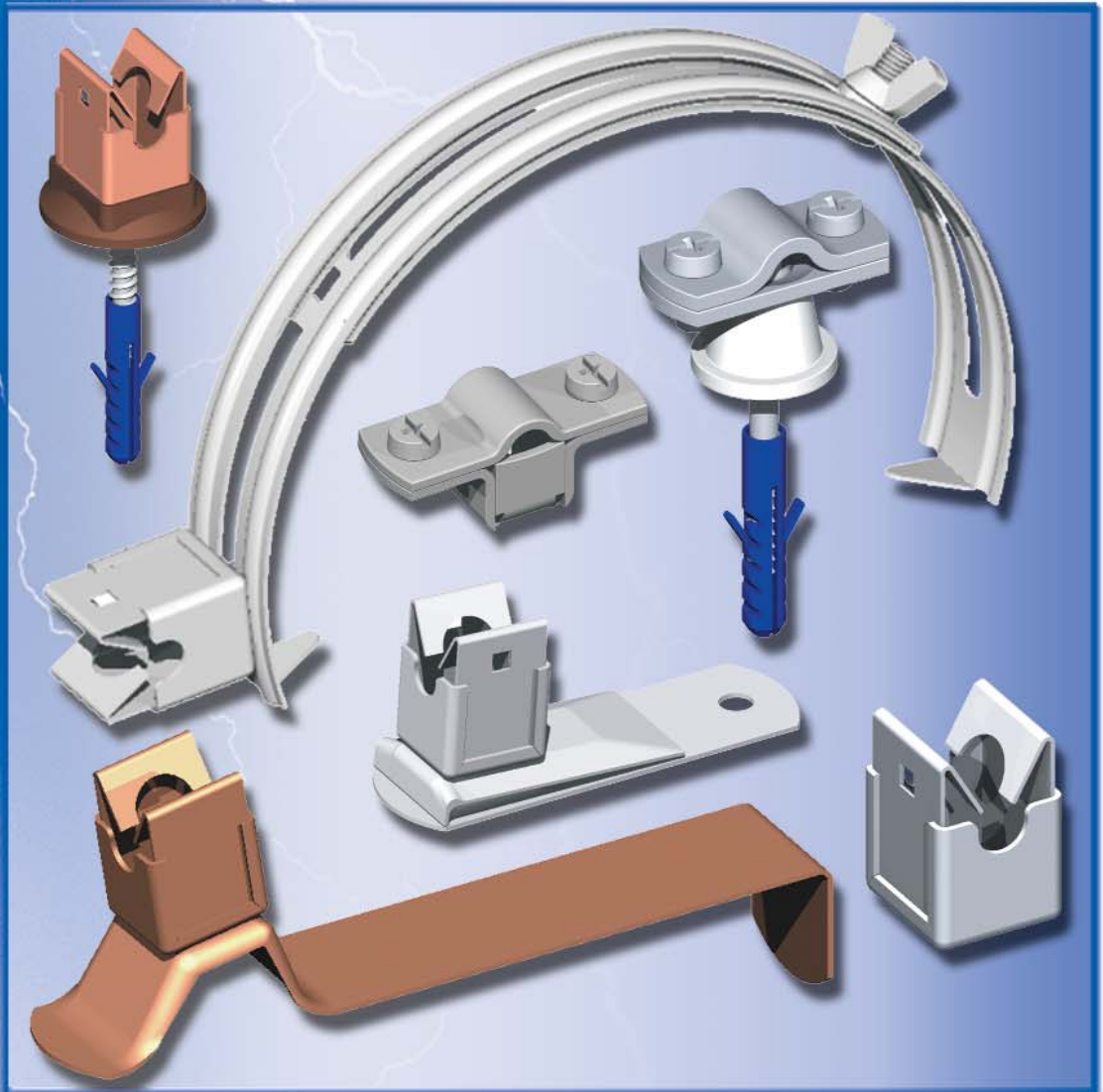

Wall & roof
conductor holders

Conductor holders

with the **Niro-Clip System**

The original Niro-Clip - the first stainless steel clip in lightning protection construction - is a multifunctional holding system for all wire attachment to roofs and walls.

Since its invention by J.PRÖPSTER in 1984, the Niro-Clip has been extremely successful. The unique construction of the patented original Niro-Clip has many advantages.

Advantages:

- maximal mechanical strength
- 100% weather resistant
- easy handling: simply push down wire into the clip and it is secured as if screwed on.

Wire can only be removed with straightener

Examples of application:

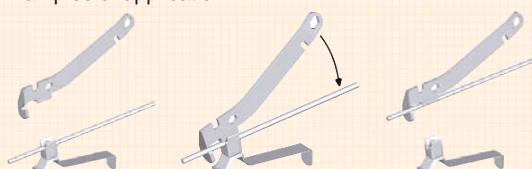

Special features:

- the Niro-Clip system is available in 2 different designs.
 - **Type fL** = **fixed conductor holder**; wire is clamped down; as safe as screwed on (e.g. order no. 111 001).
For \varnothing 8 mm wire use \varnothing 8 mm clip size.
 - **Type IL** = **loose conductor holder**; wire can shift inside holder, e.g. when wire expands (e.g. order no. 110 090).

Conductor holders for conductor \varnothing 10 mm on request.

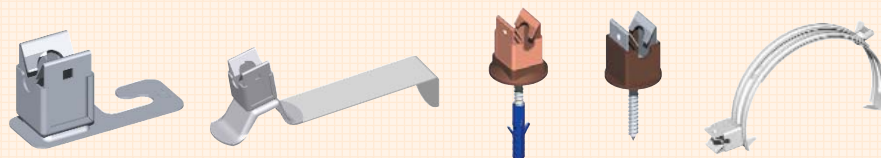

proven successful
a million times
since 1984

Niro-Clip snap-on holder

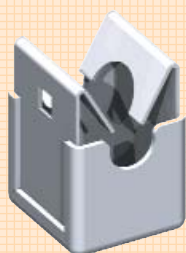

Niro-Clip snap-on holder

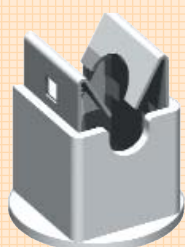

Conductor holder for attaching wire to walls.

Snap-on mechanism and base made of metal.

Specification	Bore hole	Size	Qty/pack	Order no.
Snap-on mech. / base				
Stainless steel / stainless steel	\varnothing 7	\varnothing 8/Typ fL	100	111 001
Stainless steel / stainless steel	\varnothing 7	\varnothing 8/Typ IL	100	110 090
Stainless steel coppered / copper	\varnothing 7	\varnothing 8/Typ fL	100	111 002
Stainless steel coppered / copper	\varnothing 7	\varnothing 8/Typ IL	100	110 091
Stainless steel / stainless steel	M6	\varnothing 8/Typ fL	100	111 005
Stainless steel / stainless steel	M6	\varnothing 8/Typ IL	100	110 095
Stainless steel coppered / copper	M6	\varnothing 8/Typ fL	100	111 006
Stainless steel coppered / copper	M6	\varnothing 8/Typ IL	100	110 096

Conductor holder for attaching wire to walls.

Snap-on mechanism made of stainless steel, base made of plastic.

Specification	Bore hole	Size	Qty/pack	Order no.
Snap-on mech. / base				
Stainless steel / gray plastic	\varnothing 7	\varnothing 8	100	111 003
Stainless steel / brown plastic	\varnothing 7	\varnothing 8	100	111 004
Stainless steel / gray plastic	M6	\varnothing 8	100	111 007
Stainless steel / brown plastic	M6	\varnothing 8	100	111 008

Niro-Clip with 40 mm high plastic base on request.

Niro-Clip with rosette, wood screw and ø 8 mm wallplug

Specification	Size	Qty/pack	Order no.
Snap-on mechanism / base			
Stainless steel / stainless steel	ø 8/Typ fL	100	111 031
Stainless steel / stainless steel	ø 8/Typ IL	100	110 080
Stainless steel coppered / copper	ø 8/Typ fL	100	111 032
Stainless steel coppered / copper	ø 8/Typ IL	100	110 081

Niro-Clip with screw and rosette.

Specification	Size	Qty/pack.	Order no.
Snap-on mechanism / base			
Stainless steel / gray plastic	ø 8	100	111 029
Stainless steel / brown plastic	ø 8	100	111 030

SK conductor support with screw cap, attachment element and cover rosette; fits 8 mm round conductor for attaching wires quickly and securely on walls.

Specification	Size	Qty/pack	Order no.
Aluminum, h = 20 mm	ø 8	100	1010
Aluminum, h = 30 mm	ø 8	100	1011
Copper alloy, h = 20 mm	ø 8	50	1014
Copper alloy, h = 30 mm	ø 8	50	1015

Also available without screw and wallplug.

Niro-Clip snap-on holder



Niro-Clip snap-on holder



Screw caps SK conductor support

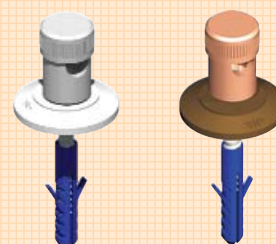

Conductor holder

with fixed pin



with loose pin



Conductor holder

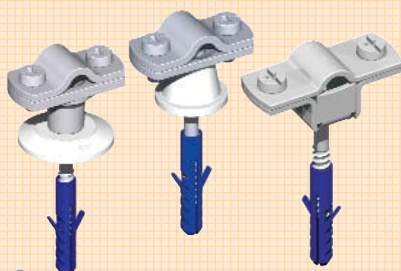

Conductor holder

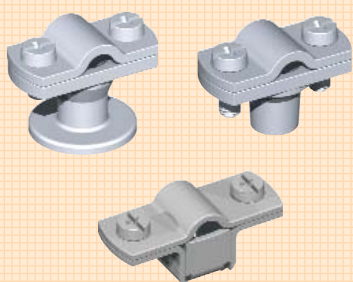

Conductor holder

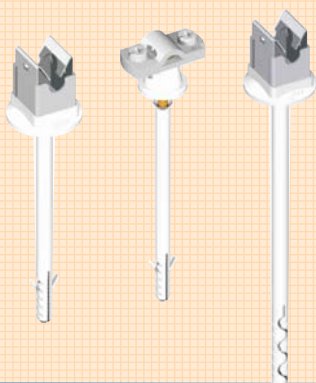

Conductor holder

with fixed pin for \varnothing 8-10 mm round conductor; mounted with M6 DIN 84 (304) screws

Specification	Length	Qty/pack	Order no.
Steel/galvanized	100 lg	100	1038
Steel/galvanized	150 lg	50	1039
Copper alloy	100 lg	100	1035
Copper alloy	120 lg	100	1036
Copper alloy	150 lg	50	1037
Stainless steel	100 lg	50	2030

See page 40 for holders for conductor installation behind downpipe.

Specification	Length	Qty/pack	Order no.
Aluminum with steel pin	70	100	110 270
Aluminum with steel pin	100	100	110 271
Aluminum with steel pin	150	50	110 272
Steel/galvanized with steel pin	70	100	110 050
Steel/galvanized with steel pin	100	100	110 045
Steel/galvanized with steel pin	150	50	110 047
Stainless steel with stainless steel pin	100	100	110 276
Stainless steel with stainless steel pin	150	50	110 277
Copper with stainless steel pin	100	100	110 280
Copper with stainless steel pin	150	50	110 281

Conductor holder for \varnothing 8-10 mm round conductor; mounted with M6 DIN 84 stainless steel (304) screws, rosette, set screws and \varnothing 8 mm wallplug

Specification	Size	Qty/pack	Order no.
Zinc diecasting - steel/galvanized M8	20 h	100	110 171
Red bronze M8	20 h	100	110 172
Steel galvanized/plastic	30 h	100	1034
Aluminum/plastic	30 h	100	1033
Copper/plastic	30 h	100	1032
Stainless steel/plastic	30 h	100	1031
Stainless steel M8	15 h	100	1132

Conductor holder for \varnothing 8-10 mm round conductor; mounted with M6 DIN 84 stainless steel (304) screws.

Specification	Size	Qty/pack	Order no.
Zinc diecasting/steel/galvanized with M6 female thread	20 h	100	110 069
Zinc diecasting/steel/galvanized with M8 female thread	20 h	100	110 071
Zinc diecast with M6 rosette	23 h	100	110 160
Zinc diecast with M8 rosette	23 h	100	110 161
Red bronze with M8 female thread	20 h	100	110 072
Stainless steel with M8 female thread	15 h	100	1137

Conductor holder for insulated walls with insulation thickness of 40-60 mm

Specification	insulation thickness	Size	Qty/pack	Order no.
Holder				
Niro-Clip stainless steel	40 - 60 mm	\varnothing 8/Typ fL	50	110 030
Niro-Clip copper	40 - 60 mm	\varnothing 8/Typ fL	50	110 031
Niro-Clip stainless steel	60 - 120 mm	\varnothing 8/Typ fL	50	110 056
Aluminum cover	40 - 60 mm	\varnothing 8	50	110 034
Copper cover	40 - 60 mm	\varnothing 8	50	110 035
Aluminum cover	40 - 60 mm	\varnothing 16	50	110 038
Copper cover	40 - 60 mm	\varnothing 16	50	110 039
Galvanized steel cover	40 - 60 mm	30 x 3.5	50	110 042
Stainless steel	40 - 60 mm	30 x 3.5	50	110 043

Holders for additional insulation thicknesses available on request.

Pipe clamp to install conductors behind rainwater downpipes. **Advantage:** no additional wall holders required! Fast, clean installation without drilling. Easy removal, e.g. for painting.

Specification	Size	Qty/pack	Order no.
With M6 bolt and nut			
Steel galvanized	ø 80	25	111 222
Steel galvanized	ø 100	25	111 225
Steel galvanized	ø 120	25	111 227
Copper	ø 80	25	111 232
Copper	ø 100	25	111 235
Copper	ø 120	25	111 237
Aluminum	ø 100	25	111 265
Aluminum	ø 110	25	111 266
Aluminum	ø 120	25	111 267
With M6 bolt and through thread (without nut)			
Steel galvanized	ø 80	25	111 222 G
Steel galvanized	ø 100	25	111 225 G
Steel galvanized	ø 120	25	111 227 G
Copper	ø 80	25	111 232 G
Copper	ø 100	25	111 235 G
Copper	ø 120	25	111 237 G
Aluminum	ø 100	25	111 265 G
Aluminum	ø 110	25	111 266 G
Aluminum	ø 120	25	111 267 G
Additional diameters on request!			

Pipe clamp to install conductors behind rainwater downpipes. **Advantage:** no additional wall holders required! Fast, clean installation without drilling.

Specification	Size	Qty/pack	Order no.
All parts stainless steel	ø 60-120	25	110 250
All parts stainless steel	ø 80-150	25	110 251
All parts copper	ø 60-120	25	110 252
All parts copper	ø 80-150	25	110 253

Saddle clamp

Specification	Dist. btw. holes	Material	Qty/pack	Order no.
with 2 ø 7 mm bore holes	28/ø 7-10	Aluminum	100	110 001
	38/ø 7-10	Aluminum	100	110 002
	38/ø 16	Aluminum	100	110 003
	28/ø 8-10	Copper	100	110 004
	38/ø 16	Copper	100	110 005
	28/ø 8-10	Stainless steel	100	110 006
	38/ø 16	Stainless steel	100	110 007
	38/flat	Aluminum	100	110 008
with 1 ø 7 mm bore hole for flush mounting for conductor ø 8 - 11 mm		Stainless steel	100	110 009
		Copper	100	110 010
with strokeplug for flush mounting for conductor ø 8 - 11 mm		Stainless steel	50	110 014
Saddle clamp for band Fixing directly on the wall	30 x 3,5	Stainless steel	100	110 015

Miscellaneous

Specification	Material	Qty/pack	Order no.
Rosette	gray plastic	100	1042
Rosette	brown plastic	100	1046
Rosette for Niro-Clip	gray plastic	100	1047
Rosette for Niro-Clip	brown plastic	100	1048
Rosette	Stainless steel	100	111 049
Spacing base	gray plastic	100	111 047
Spacing base	brown plastic	100	111 048

Pipe clamps with bead



Universal pipe clamp with bead



Saddle clamp

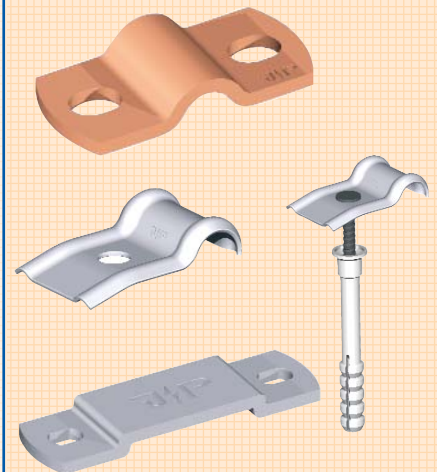

Miscellaneous

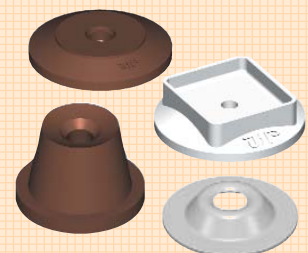

Flat band holder

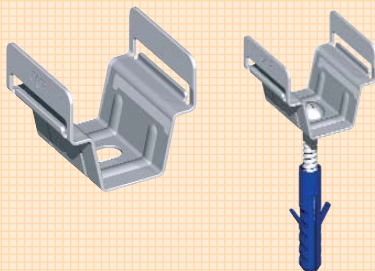

Flat band holder

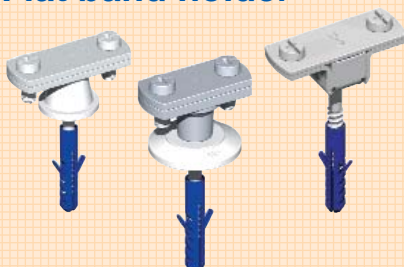

Flat band holder

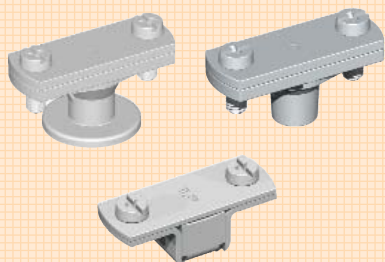

Conductor holder

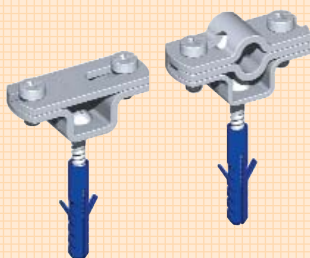

Flat band holder

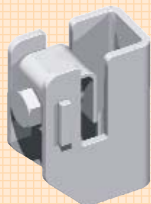

Flat band holder for 30 mm wide flat band

Specification	Size	Qty/pack	Order no.
Stainless steel with stock screw and \varnothing 8 mm wallplug	30 x 3,5	100	1178
Stainless steel	30 x 3,5	100	1178 S

Flat band holder for 30 mm wide flat band; with rosette, stock screw and \varnothing 8 mm wallplug

Specification	Size	Qty/pack	Order no.
Zinc diecasting - steel/galvanized M8	20 h	100	110 178
Steel/galvanized with wood screw and wallplug	30 h	100	1183
Aluminum / plastic with wood screw and wallplug	30 h	100	1185
Stainless steel / plastic with wood screw and wallplug	30 h	100	1184
Stainless steel with wood screw and wallplug	30 h	100	1121

Flat band holder for 30 mm wide flat band with female thread

Specification	Size	Qty/pack	Order no.
Zinc diecasting - steel/galvanized M6	20 h	100	110 077
Zinc diecasting - steel/galvanized M8	20 h	100	110 078
Zinc diecasting with rosette M6	23 h	100	110 162
Zinc diecasting with rosette M8	23 h	100	110 163
Stainless steel M6	30 h	100	1128

Conductor holder

for flat band or rope with DIN 96 (304) button head screw and \varnothing 8 wallplug

Specification	Size	Qty/pack	Order no.
Steel galvanized	30 x 3,5	100	1180
Steel galvanized	40 x 4,0	100	2037
Copper	30 x 3,5	100	1182
Copper	40 x 4,0	100	2039
Stainless steel	30 x 3,5	100	1181
Stainless steel	\varnothing 10,5-14	100	110 265

Flat band holder for wall attachment. With M8 pressing screw and pressing plate

Specification	Slot width	Distance to wall	Qty/pack	Order no.
Steel galvanized	10 mm	18 mm	100	911 314
Copper	10 mm	18 mm	100	911 576

Rod Holder for interception rods and earth terminals with M 6x16 (304) screws, rosette or base, fastening screw and ø 8 wallplug

Specification	Size	Qty/pack	Order no.
Zinc diecasting/steel galvanized M8	ø 16/20 h	100	110 175
Red bronze M8	ø 16/20 h	100	110 176
Zinc diecasting/steel galvanized M8	ø 13/20 h	100	110 187
Steel galvanized	ø 16/30 h	100	1190
Aluminum	ø 16/30 h	100	1187
Copper	ø 16/30 h	100	1188
Stainless steel	ø 16/30 h	100	1189
Steel galvanized	ø 13/30 h	100	1194
Stainless steel with female thread M6	ø 16/30 h	100	1142

Rod holder



Rod Holder for interception rods and earth terminals with M 6x16 (304) screws

Specification	Size	Qty/pack.	Order no.
Zinc diecasting/steel galvanized M6	ø 16/20 h	100	110 073
Zinc diecasting/steel galvanized M8	ø 16/20 h	100	110 075
Zinc diecasting with rosette M6	ø 16/23 h	100	110 164
Zinc diecasting with rosette M8	ø 16/23 h	100	110 165
Red bronze M8	ø 16/20 h	100	110 076
Zinc diecasting/steel galvanized M8	ø 13/20 h	100	110 087
Stainless steel with female thread M6	ø 16/30 h	100	1147

Rod holder

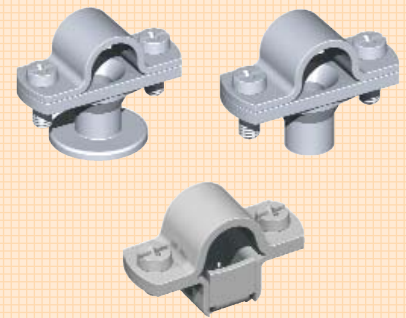

Rod Holder with **fixed pin** for interception rods and earth terminals; mount with M6 x 16 DIN 84 (304) screws

Specification	Size	Qty/pack	Order no.
Steel/galvanized with fixed pin	ø 16, 100 lg	100	1195
Steel/galvanized with fixed pin	ø 16, 150 lg	50	1196
Copper alloy with fixed pin	ø 16, 100 lg	100	1191
Copper alloy with fixed pin	ø 16, 120 lg	100	1192
Copper alloy with fixed pin	ø 16, 150 lg	50	1193
Steel/galvanized with fixed pin	ø 13, 100 lg	50	1199
Steel/galvanized with fixed pin	ø 13, 150 lg	50	1200

Rod holder



Rod Holder with **loose pin** for interception rods and earth terminals; mount with M6 x 16 DIN 84 (304) screws

Specification	Length	Qty/pack	Order no.
Steel/galvanized with loose pin	100	100	110 046
Steel/galvanized with loose pin	150	50	110 048
Stainless steel with loose stainl. steel pin	100	100	110 278
Stainless steel with loose stainl. steel pin	150	50	110 279
Copper with loose stainless steel pin	100	100	110 282
Copper with loose stainless steel pin	150	50	110 283
Steel/galvanized with loose pin	ø 13, 100 lg	50	110 049
Steel/galvanized with loose pin	ø 13, 150 lg	50	110 049 S

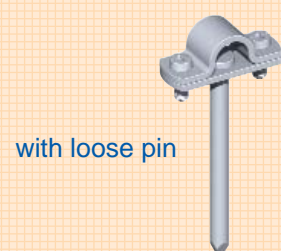

Roof conductor holder with snap-on base



Roof conductor holder with snap-on base



Roof conductor holder with clamping jaws and Niro-Clip



Roof conductor support with Niro-Clip

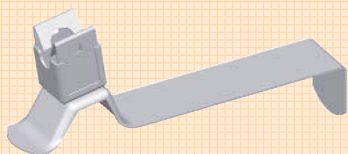

Roof conductor support with screw attachment



Roof conductor holder for priolite shingles and slate roofs (large clamping range for shingles)

Specification	Holder	Clamp range.	Size	Qty/pack	Order no.
Base	Holder				
Stainless steel	Niro-Clip, stainless steel	max. 5mm	ø 8/Typ fL	100	111 010
Stainless steel	Niro-Clip, stainless steel	max. 5mm	ø 8/Typ IL	100	111 011
Stainless steel	Niro-Clip, stainless steel	max. 18mm	ø 8/Typ fL	100	111 525
Stainless steel	Niro-Clip, stainless steel	max. 18mm	ø 8/Typ IL	100	111 527
Copper	Niro-Clip w/ copper base	max. 5mm	ø 8/Typ fL	100	111 012
Copper	Niro-Clip w/ copper base	max. 5mm	ø 8/Typ IL	100	111 013
Copper	Niro-Clip w/ copper base	max. 18mm	ø 8/Typ fL	100	111 526
Copper	Niro-Clip w/ copper base	max. 18mm	ø 8/Typ IL	100	111 528

Roof conductor holder for slate roofs; especially well suited for later installation!

Specification	Holder	Size	Qty/pack	Order no.
Base	Holder			
Stainless steel w/ tooth	Niro-Clip, stainless steel	ø 8/Typ fL	100	111 033
Stainless steel w/ tooth	Niro-Clip, stainless steel	ø 8/Typ IL	100	111 511
Stainless steel w/o tooth	Niro-Clip, stainless steel	ø 8/Typ fL	100	111 512
Stainless steel w/o tooth	Niro-Clip, stainless steel	ø 8/Typ IL	100	111 513
Copper with tooth	Niro-Clip with copper -base	ø 8/Typ fL	100	111 035
Copper with tooth	Niro-Clip with copper -base	ø 8/Typ IL	100	111 516

Roof conductor holder for direct clamping to smooth tiles and slabs; clamping range 5-15 mm; turn holder for clamping.

Specification	Holder	Size	Qty/pack	Order no.
Base	Holder			
Stainless steel	Niro-Clip, stainless steel	ø 8/Typ fL	100	111 550
Stainless steel	Niro-Clip, stainless steel	ø 8/Typ IL	100	111 551
Copper	Niro-Clip with copper base	ø 8/Typ fL	100	111 552
Copper	Niro-Clip with copper base	ø 8/Typ IL	100	111 553

Roof conductor support for pantiled roofs

Specification	Holder	Length	Size	Qty/pack	Order no.
Support	Holder				
Stainless steel	Niro-Clip, stainless steel	180	ø 8/Typ fL	150	111 023
Stainless steel	Niro-Clip, stainless steel	180	ø 8/Typ IL	150	111 530
Copper	Niro-Clip w/ copper base	180	ø 8/Typ fL	150	111 024
Copper	Niro-Clip w/ copper base	180	ø 8/Typ IL	150	111 532

Roof conductor support for universal application. Support riveted to holder.

Specification	Size	Qty/pack	Order no.
Stainless steel with screw attachment	L = 210	100	1062
	L = 280	100	1063
	L = 410	50	1064
Copper with screw attachment	L = 210	100	1065
	L = 280	100	1066
	L = 410	50	1067

Roof conductor support for universal applications.

Specification	Holder	Length	Size	Qty/pack	Order no.
Stainless steel	Niro-Clip made of stainless steel	210	ø 8/Typ fL	100	111 019
Stainless steel	Niro-Clip made of stainless steel	210	ø 8/Typ IL	100	111 540
Stainless steel	Niro-Clip made of stainless steel	280	ø 8/Typ fL	100	111 015
Stainless steel	Niro-Clip made of stainless steel	280	ø 8/Typ IL	100	111 541
Stainless steel	Niro-Clip made of stainless steel	410	ø 8/Typ fL	100	111 535
Stainless steel	Niro-Clip made of stainless steel	410	ø 8/Typ IL	100	111 536
Copper	Niro-Clip with copper base	210	ø 8/Typ fL	100	111 020
Copper	Niro-Clip with copper base	210	ø 8/Typ IL	100	111 545
Copper	Niro-Clip with copper base	280	ø 8/Typ fL	100	111 016
Copper	Niro-Clip with copper base	280	ø 8/Typ IL	100	111 546
Copper	Niro-Clip with copper base	410	ø 8/Typ fL	100	111 537
Stainless steel	Niro-Clip with plastic base	210	ø 8	100	111 021
Stainless steel	Niro-Clip with plastic base	280	ø 8	100	111 017
Copper	Niro-Clip with plastic base	210	ø 8	100	111 022
Copper	Niro-Clip with plastic base	280	ø 8	100	111 018

Roof conductor support for easy fold fit; takes the shape of the fold through easy flanging and pressing. Aluminum design with stainless steel reinforced trapezoid.

Specification	Size	Qty/pack	Order no.
Holder made of aluminum with Niro-Clip	ø 8/Typ fL	150	111 043
Holder made of aluminum with Niro-Clip	ø 8/Typ IL	150	111 043 S
Holder made of copper with Niro-Clip	ø 8/Typ fL	150	111 044
Holder made of copper with Niro-Clip	ø 8/Typ IL	150	111 044 S

Roof conductor support for universal application. **Advantages:** one piece, no screws or plastic parts! Quick and easy installation! Made of corrosion resistant stainless steel!

Specification	Length	Size	Qty/pack	Order no.
Stainless steel	L = 210	ø 8	100	111 050
Stainless steel	L = 280	ø 8	100	111 051
Stainless steel	L = 180 angled	ø 8	100	111 052

Roof conductor holder that fits all tile shapes; for ø 8 mm round conductor; to be used on the ridge and the roof surface with ø 12 mm bore hole.

Specification	Size	Qty/pack	Order no.
Aluminum SK holder with socket	ø 8	100	1021
Copper alloy SK holder with socket	ø 8	50	1022
Niro-Clip stainless steel with socket	ø 8/Typ fL	100	1028
Niro-Clip stainless steel with socket	ø 8/Typ IL	100	1027
Niro-Clip copper with socket	ø 8/Typ fL	100	1029

Roof conductor support with Niro-Clip

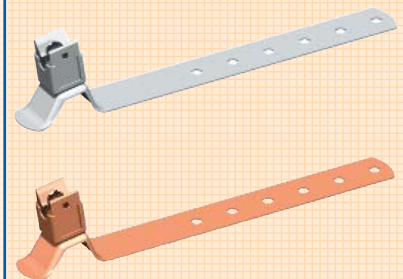

Roof conductor support for interlocking tiles

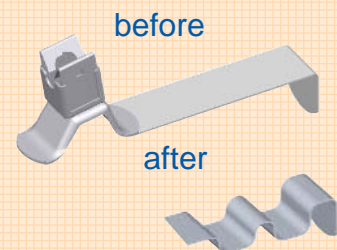

Roof conductor holder J. Pröpster patent support

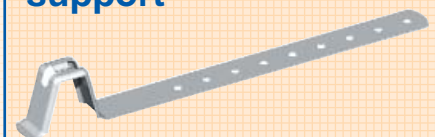

Roof conductor holder

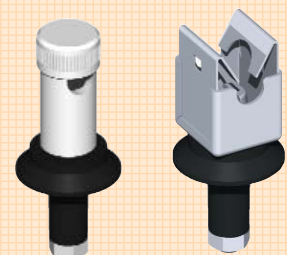

Roof conductor support (DBP) for Kal-Zip systems

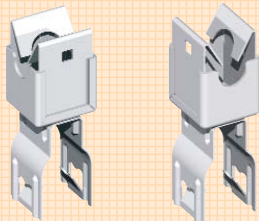

Roof conductor support (DBP)

for Kal-Zip systems, Snap-on mechanism and base made of metal.

Specification	Size	Qty/pack	Order no.
Stütze mit holder			
Stainless steel Niro-Clip; transverse to the bulge	ø 8	100	111 750
Stainless steel Niro-Clip; lengthwise to the bulge	ø 8	100	111 750 S

Roof conductor support for Kal-Zip systems

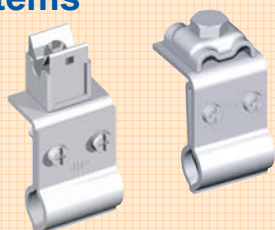

Roof conductor support for Kal-Zip systems; to attach interception and down conductors; diagonal and parallel conductor arrangement.

Specification	Size	Qty/pack	Order no.
Aluminum with Niro-Clip	ø 8/Typ fL	50	1309
Aluminum with Niro-Clip	ø 8/Typ IL	50	913 615
All parts stainless steel with Niro-Clip	ø 8/Typ fL	50	913 616
All parts stainless steel with Niro-Clip	ø 8/Typ IL	50	913 617
Aluminum with dual cross connection clamp	ø 8	50	1309 S
Stainless steel with dual cross connection clamp	ø 8	50	1308 S

Roof conductor support

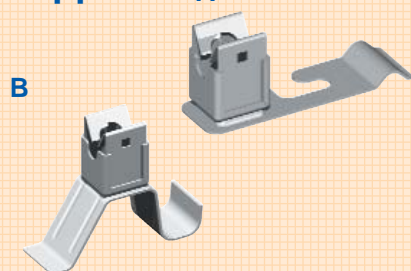

Roof conductor support for double-depression interlocking tiles.

Specification	Size	Qty/pack	Order no.
Stainless steel with Niro-Clip	ø 8/Typ fL	100	111 455 A
Copper with Niro-Clip	ø 8/Typ fL	100	111 456 A
Stainless steel with Niro-Clip	ø 8/Typ fL	100	111 451 B
Stainless steel with Niro-Clip	ø 8/Typ IL	100	111 453 B
Copper with Niro-Clip	ø 8/Typ fL	100	111 452 B
Copper with Niro-Clip	ø 8/Typ IL	100	111 454 B

Roof conductor support



Roof conductor support for corrugated roofs, to attach to roof ridge and down conductors, diagonal and parallel conductor arrangement.

Specification	Size	Qty/pack	Order no.
All parts made of stainless steel with Niro-Clip	ø 8/Typ fL	100	111 027
All parts made of stainless steel with Niro-Clip	ø 8/Typ IL	100	111 045

Roof conductor support with Niro-Clip

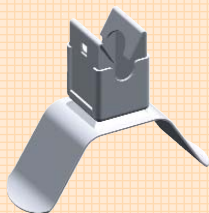

Roof conductor support as intermediate support for corrugated roofs

Specification	Size	Qty/pack	Order no.
Holder made of stainless steel with Niro-Clip	ø 8/Typ fL	100	1095

Roof conductor holder



Roof conductor holder for corrugated roofs; for installing in troughs

Specification	Size	Qty/pack	Order no.
Holder made of stainless steel with Niro-Clip	ø 8/Typ fL	100	1088

Universal roof conductor holder in accordance with DIN 48 826 B.

Fits all tile sizes; universally adjustable wire attachment. **Advantage:** one type fits all!

Specification	Holder	Size	Qty/pack	Order no.
Clip	Holder			
Stainless steel	Stainless steel	ø 8/Typ fL	100	111 144
Stainless steel	Stainless steel	ø 8/Typ IL	100	111 136
Copper	Stainless steel coppered	ø 8/Typ fL	100	111 145
Copper	Stainless steel coppered	ø 8/Typ IL	100	111 137

Roof conductor holder with two tension springs made of stainless steel for permanent and fast assembly on the roof ridge.

Specification	Size	Qty/pack	Order no.
All parts made of stainless steel with Niro - Clip on the side	ø 8/Typ fL	25	111 191
Copper with Niro - Clip on the side	ø 8/Typ fL	25	111 196
All parts made of stainless steel with Niro - Clip on the side	ø 8/Typ IL	25	111 175
Copper with Niro - Clip on the side	ø 8/Typ IL	25	111 176

Roof conductor holder with two tension springs made of stainless steel for permanent and fast assembly on the roof ridge.

Specification	Size	Qty/pack	Order no.
All parts made of stainless steel with Niro-Clip in center	ø 8/Typ fL	25	111 192
Copper with Niro-Clip in center	ø 8/Typ fL	25	111 197
All parts made of stainless steel with Niro-Clip in center	ø 8/Typ IL	25	111 177
Copper with Niro-Clip in center	ø 8/Typ IL	25	111 178

Roof conductor holder with two tension springs made of stainless steel for permanent and fast assembly on the roof ridge.

Specification	Size	Qty/pack	Order no.
All parts made of stainless steel with roof conductor holding clip	ø 8	25	111 190
Copper with roof conductor holding clip	ø 8	25	111 195

Roof conductor holder with Niro-Clip

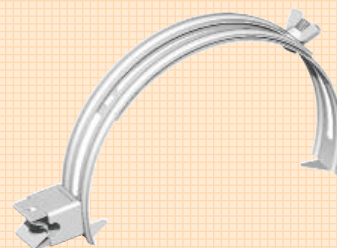

Roof conductor holder with Niro-Clip (with lateral conductor mounting)

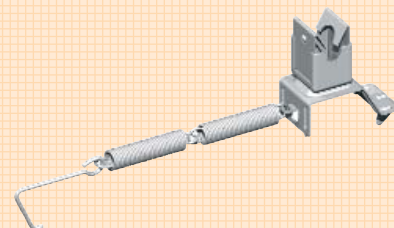

Roof conductor holder with Niro-Clip (with central conductor mounting)

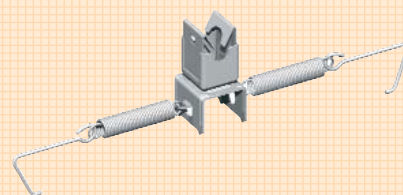

Roof conductor holder (with lateral conductor mounting)

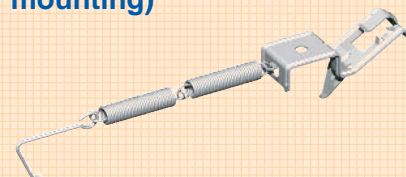

PR-ÖKO 2 roof conductor support



Roof conductor sup- ports

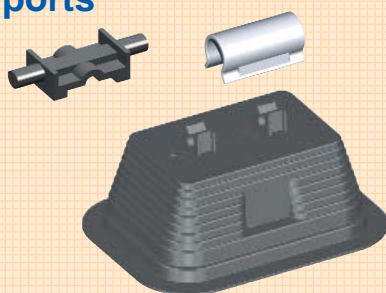

Adhesive support with Niro-Clip (DBP) for foil roofs

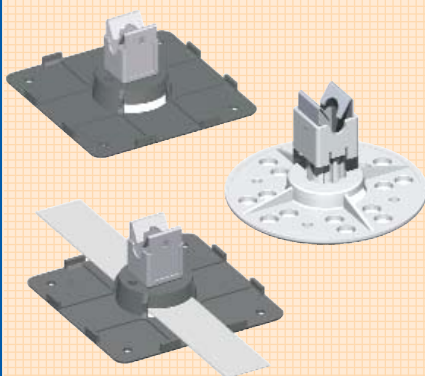

Roof conductor sup- port with Niro-Clip



Advantages:

- PR-ÖKO 2 has a weather resistant plastic part made of HD-PE material; can be installed at a minimum temperature of minus 10°
- PR-ÖKO 2 contains a compressed concrete block that is 100% frost-proof and recyclable
- PR-ÖKO 2 has no frost-sensitive cavities and recesses (weight: 1 kg in accordance with DIN 4889)
- PR-ÖKO 2 features 2 conductor holders for double security

Specification	Size	Qty/pack	Order no.
Without total encasing	ø 8	10	111 630

Roof conductor support for flat roofs; materials made of black, weather-resistant plastic and frost-proof concrete filling with two conductor holders. Weight 1000 g; model will be discontinued since material is difficult to recycle.

Specification	Size	Qty/pack	Order no.
With enclosed plastic casing	ø 8	12	1161
in accordance with DIN 48 829 B1	ø 10	12	1162
Clasp made of stainless steel to affix roof conductor support on wire	ø 8	100	1163
Adapter for 20 x 2,5 mm and 30 x 3,5 mm flat band	20 x 2,5 mm 30 x 3,5 mm	100	1164

Roof conductor support to be glued directly onto foil roofs and/or to attach to bonded holding bands.

Specification	Size	Qty/pack	Order no.
Base plate with Niro-Clip	ø 8/Typ <i>IL</i>	100	111 604
Round base plate with Niro-Clip and plastic base	ø 8	100	111 635

Upon request, the base plate can also be equipped with other conductor holders.

Roof conductor support for cardboard roofs, flat roofs and walls.

Specification	Size	Qty/pack	Order no.
Snap-on mech. Base Plate			
Stainless steel Stainless steel Stainless steel	ø 8/Typ <i>fL-20 h</i>	100	1167
Stainless steel Gray plastic Steel/galvanized	ø 8/Typ <i>fL-40 h</i>	100	1169

Additional specifications on request